



SAFESTOP PEDESTRIAN GUARDRAIL

**INNOVATIVE GUARDRAILS
KEEP YOUR PEOPLE SAFE**

*Strong uprights and flexible rails
provide ultimate stopping power*

THE MCCUE DIFFERENCE

HI, WE'RE MCCUE & WE MAKE SAFETY EASY!

Our innovative, impact-tested barriers safely stop fast-moving material handling vehicles — protecting your people and your facility. With engineered materials that work together, we're revolutionizing safety barrier innovation with these three principles:



SAFER IMPACTS

Strong, floor-mounted rail designed to bring heavy trucks to a stop.



SHOCK ABSORPTION

Absorbs impacts — with limited deflection — to keep your people safe.



EASY INSTALL

Simple install with standard hardware and tools.

**KEEP YOUR OPERATIONS SAFE AND YOUR WORKFORCE SAFER WITH THE WORLD'S MOST
ADVANCED SAFETY BARRIERS — SPEAK TO A SAFETY SPECIALIST TODAY (800) 800-8503**



EASY-TO-CONFIGURE:
Modular rails and connectors allow for endless configurations.

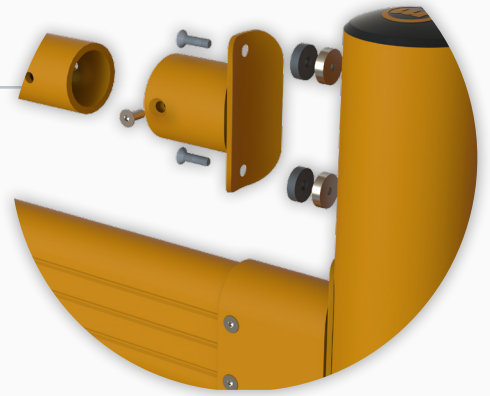

SAFER IMPACTS:
Proprietary rail connection provides unparalleled impact absorbency.

STOPPING POWER:
Industry-leading upright strength from shock-absorbing post technology.

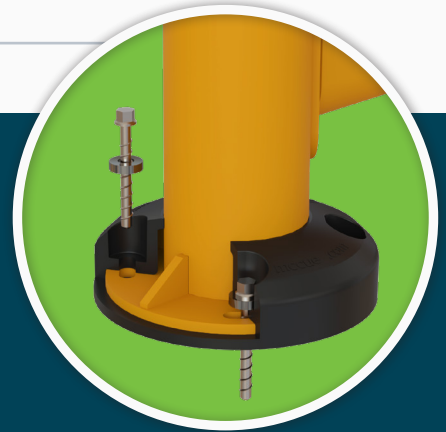

SAFESTOP PEDESTRIAN GUARDRAIL

Meet **SafeStop Pedestrian GuardRail**, a strong floor-mounted barrier that safely stops moving material handling vehicles. Engineered to safely absorb impacts —with minimum deflection— to protect your people, workspace, and bottom line.

HOW IT WORKS

Pedestrian GuardRail is packed full of innovative technology to safely stop heavy machinery. Upon impact, its reinforced uprights offer strength while its shock-absorbing rails flex to dissipate impact energy — keeping your operators, forklifts, and facility safe.

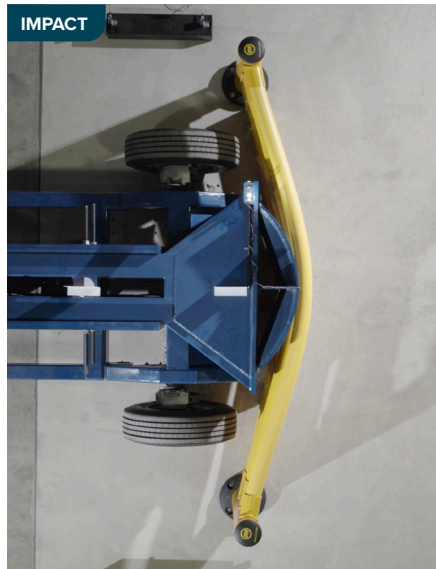
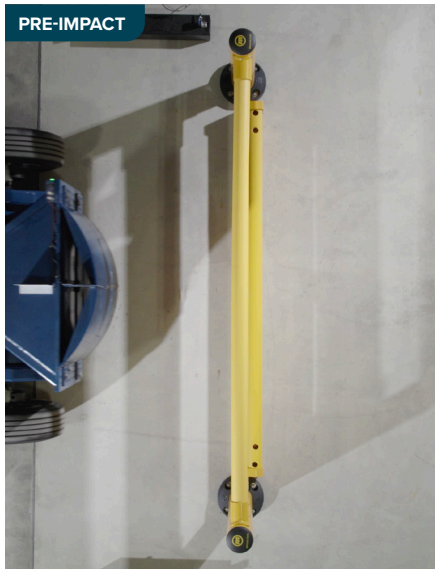

* PATENTS PENDING

IMPACT TESTING

Rigorous product testing at the highest standard.

Ultimate Strength Rating



SafeStop Pedestrian GuardRail
16,226 ft-lbs (22,000 J)



SafeStop Pedestrian GuardRail with FloorGuard
21,389 ft-lbs (29,000 J)

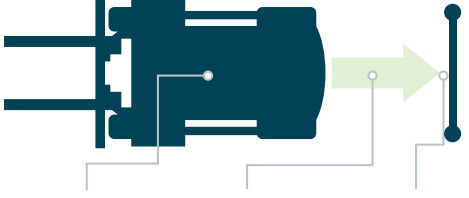

$\frac{1}{2} \text{ MASS X VELOCITY}^2 = \text{ENERGY}$

90°	21,389 ft-lbs	29,000 J
-----	---------------	----------

45°	30,254 ft-lbs	41,018 J
-----	---------------	----------

30°	42,779 ft-lbs	58,000 J
-----	---------------	----------

WHAT DOES 21,389 FT LBS (29,000 J) MEAN TO YOU?



Weight:
2,000 lb Pallet Jack

0k 2k 4k 6k 8k 10k 12k 14k 16k 18k 20k

Impact Speed:
17.9 mph at 90°

0 2 4 6 8 10 12 14 16 18



Weight:
6,000 lb Walkie Rider

0k 2k 4k 6k 8k 10k 12k 14k 16k 18k 20k

Impact Speed:
10.3 mph at 90°

0 2 4 6 8 10 12 14 16 18



Weight:
10,000 lb Loaded Forklift

0k 2k 4k 6k 8k 10k 12k 14k 16k 18k 20k

Impact Speed:
8.0 mph at 90°

0 2 4 6 8 10 12 14 16 18



Weight:
18,000 lb Turret Truck

0k 2k 4k 6k 8k 10k 12k 14k 16k 18k 20k

Impact Speed:
6.0 mph at 90°

0 2 4 6 8 10 12 14 16 18

MATERIAL PROPERTIES

BARRIER DEFLECTION:

Flexible rails for maximum energy absorption.

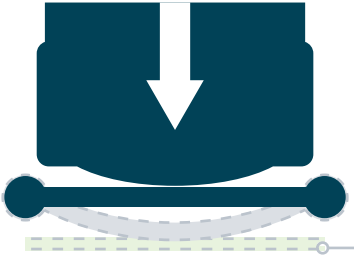



Barrier Deflection
22.5" (571.5 mm)

Anchor Specifications:

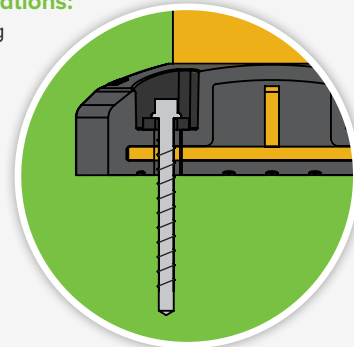
A shock-absorbing anchor system protects both the anchors and the floor.



	Working Temperatures	32°F-130°F (0°C-54°C)
	Toxicity	Not Hazardous

	Flammability	Does Not Easily Ignite
	REACH / TSCA / DSL	Compliant

* PATENTS PENDING

SAFESTOP PEDESTRIAN GUARDRAIL

SafeStop Pedestrian GuardRail

Hardware included.

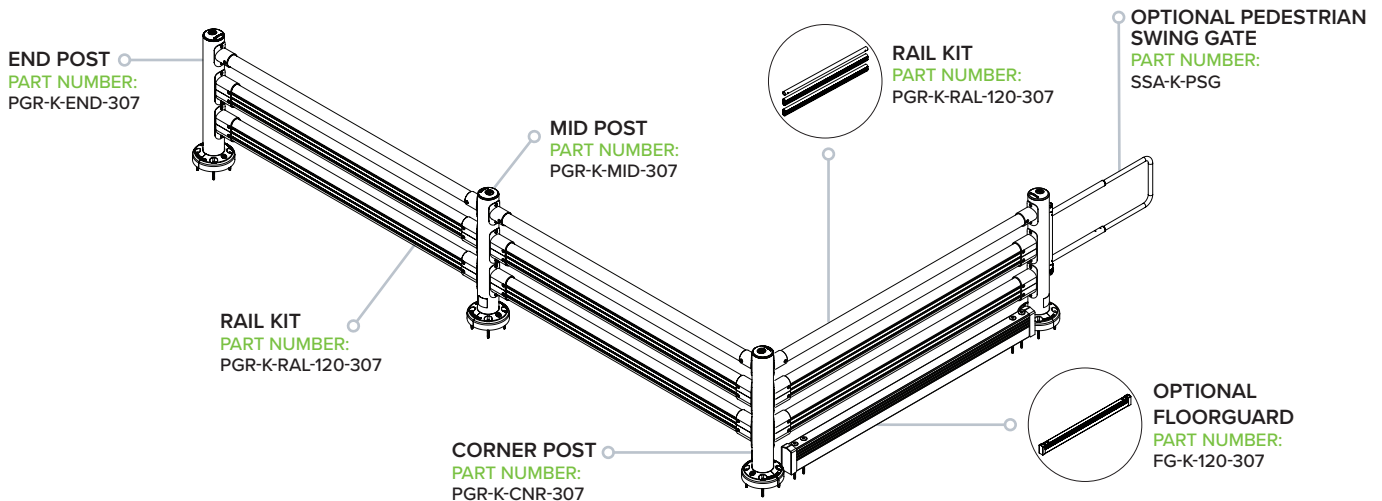
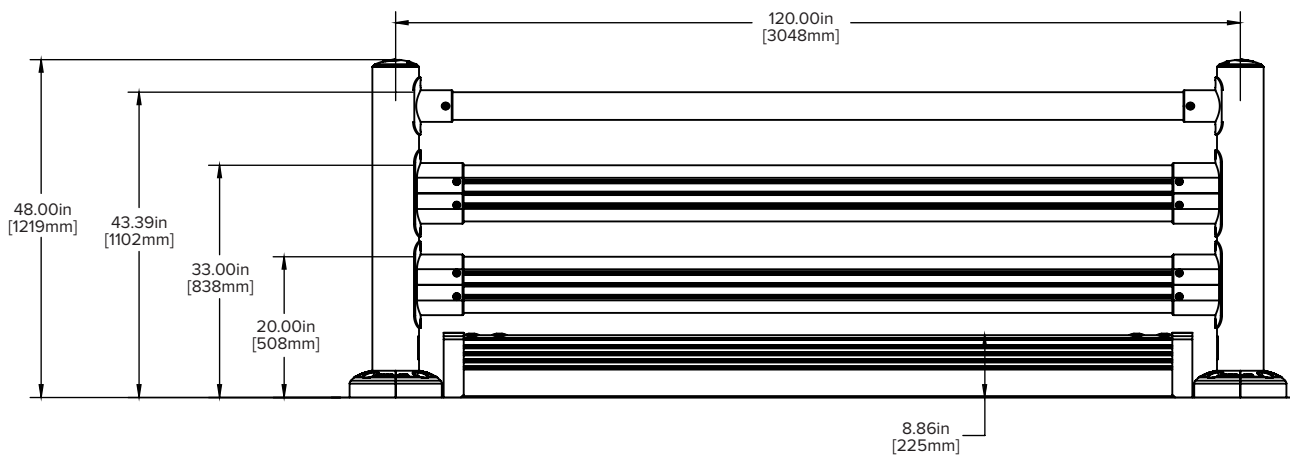
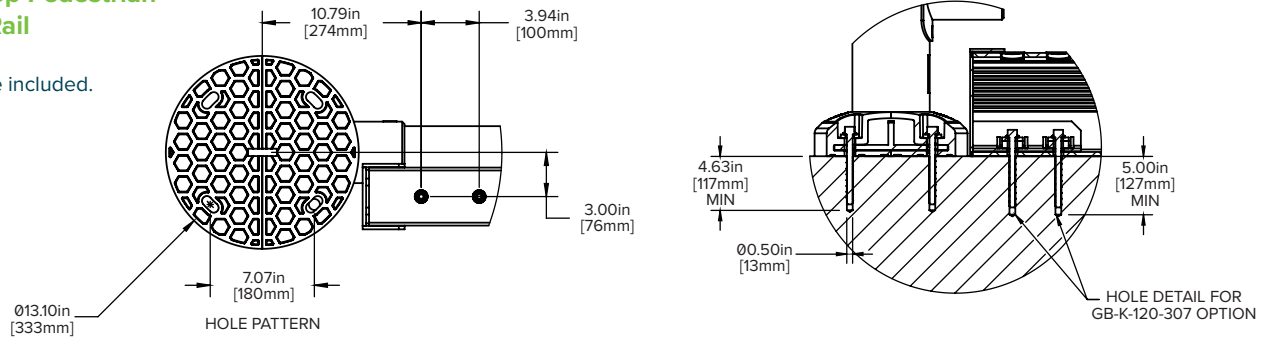

* PATENTS PENDING